

I calcolatori: dai primi a quelli super

Storia dell'Informatica
a.a. 2020/21

- Cos'è un calcolatore
- I “primi”: ENIAC, Baby, EDSAC...
- I “primi” commerciali: LEO, UNIVAC, IBM...
- Grandi, davvero
- Dalle mille valvole ai transistor, ai super

- David Hilbert, 1900 Parigi 23 problemi
 - 1900 Parigi, 23 problemi
 - Anni '20, il “Programma”
- Alonzo Church, 1936
 - Lambda calcolo
- Alan Turing, 1936
 - M. di T. universale
- E anche
 - Russel, Dedekind, Gödel, Post, Kleene...

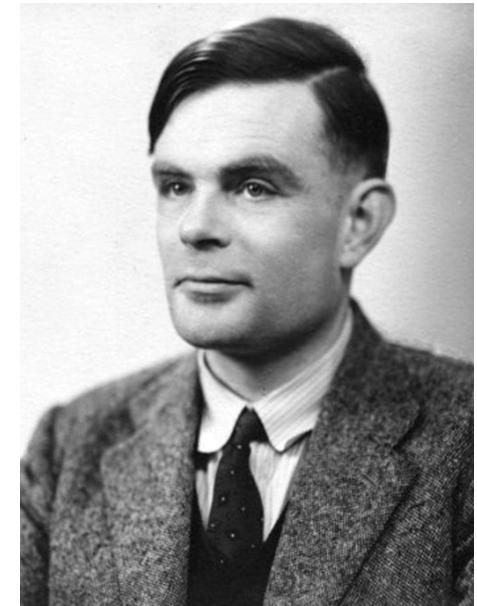

- Un formalismo per descrivere il calcolabile
 - Completo, niente sfugge, e.g. la notazione posizionale
 - Consistente, privo di contraddizioni, e.g. vedi sopra
 - Decidibile, valutabile a priori, e.g. le espressioni
- Paradosso di Russell, teoremi di Gödel
 - Logica, insieme delle proposizioni vere dimostrabili
 - Questa proposizione non può essere dimostrata
 - Se è vera, il sistema non può contenerla (incompleto)
 - Se è falsa, allora può essere dimostrata (inconsistente)
- Entscheidungsproblem, Church & Turing

- L'equivalenza (a posteriori) dei formalismi
 - 1934, Gödel & Herbrand, funzioni ricorsive
 - 1936, Post, processi combinatori
 - 1936, Church, Lambda-Calcolo
 - 1936, Turing, Macchina Universale di T.

- La potenza dei formalismi
 - Esprimono e trattano i procedimenti calcolabili
 - Sono “macchine” definite da regole, finite
 - Non ce ne sono di più potenti (non se ne sono trovati)
 - Tesi di Church-Turing, formulata da Kleene (1952)

- First Draft of a Report on the EDVAC
 - John Von Neumann, Hermann Goldstine, 24 copie
 - Univ. of Pennsylvania, Moore School of Electrical Eng.
 - John Mauchly & Presper Eckert ENI/EDVAC Proj.

- 5 parti + un supporto
 - CA, central arithmetic
 - CC, central control
 - M, memory
 - I, input, da R in M
 - O, output, da M su R
 - R, recording media

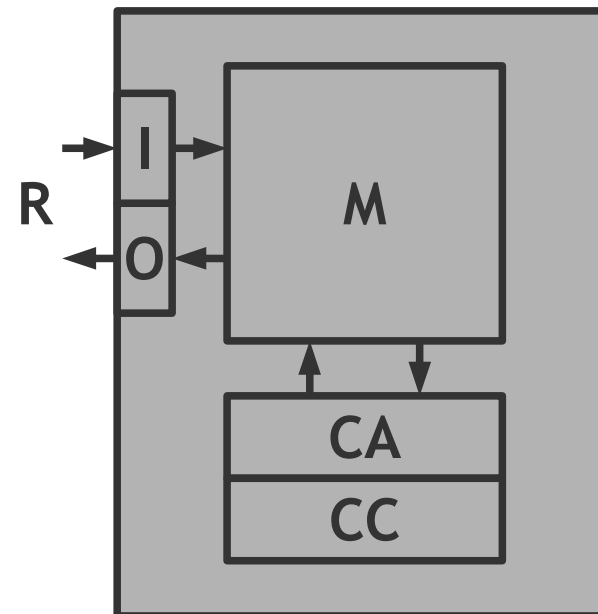

□ Progetto

- 1943
inizio
- 1946
completato
- 1947
consegnato
- 1955
spento

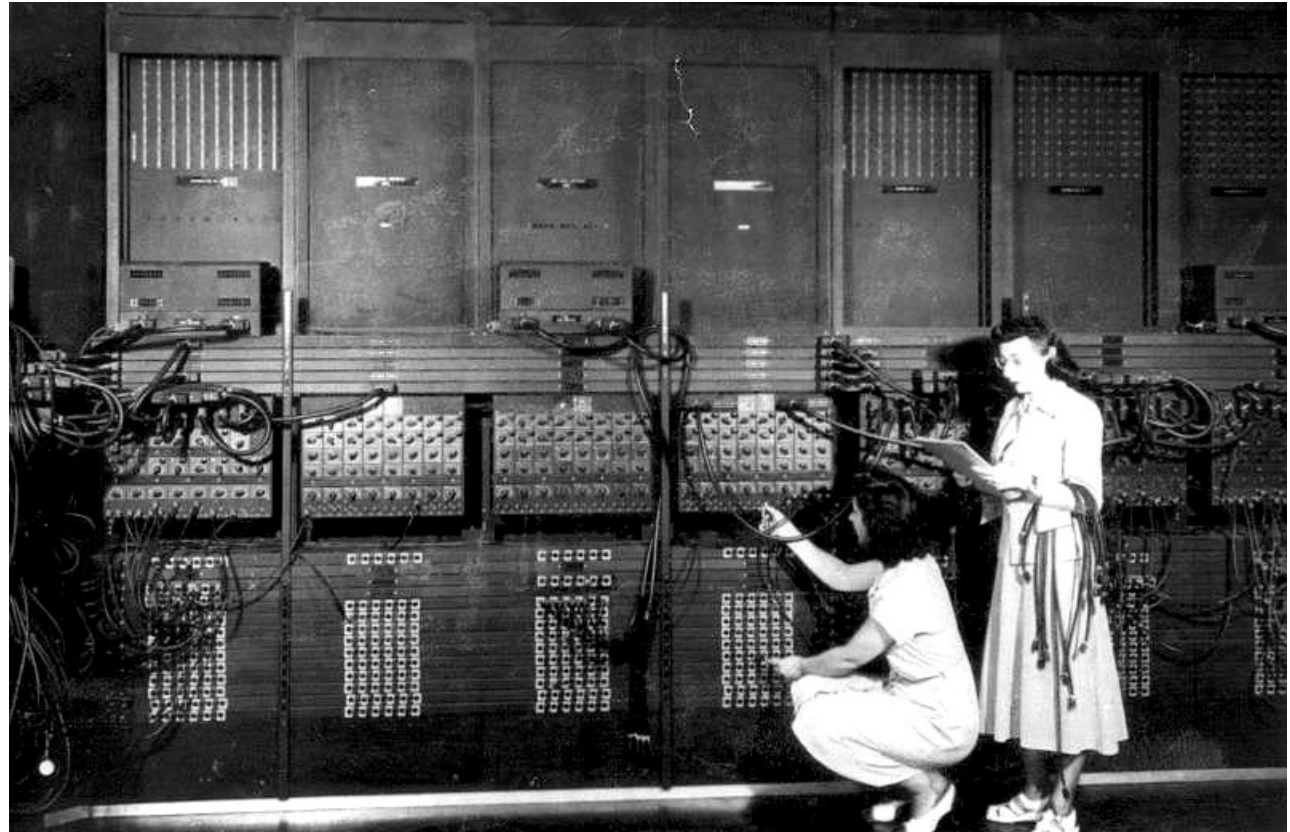

□ Caratteristiche

- Valvole (17k)
- Anche relé
- 150 KW
- Decimale
- Schede perforate
- 5000 op/sec
- “Parallelo”
- Programmabile via hardware

Feb. 4, 1964 J. P. ECKERT, JR., ET AL 3,120,606
 ELECTRONIC NUMERICAL INTEGRATOR AND COMPUTER
 Filed June 26, 1947 91 Sheets-Sheet 1

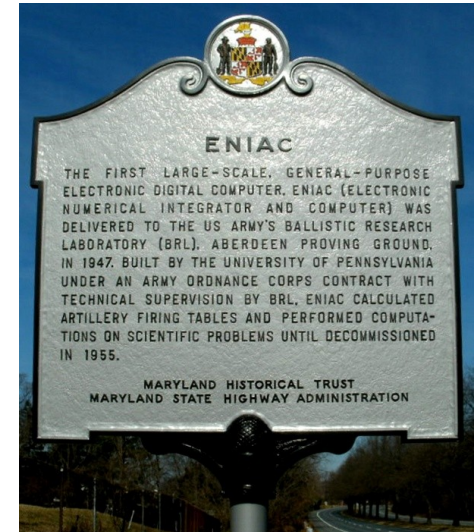
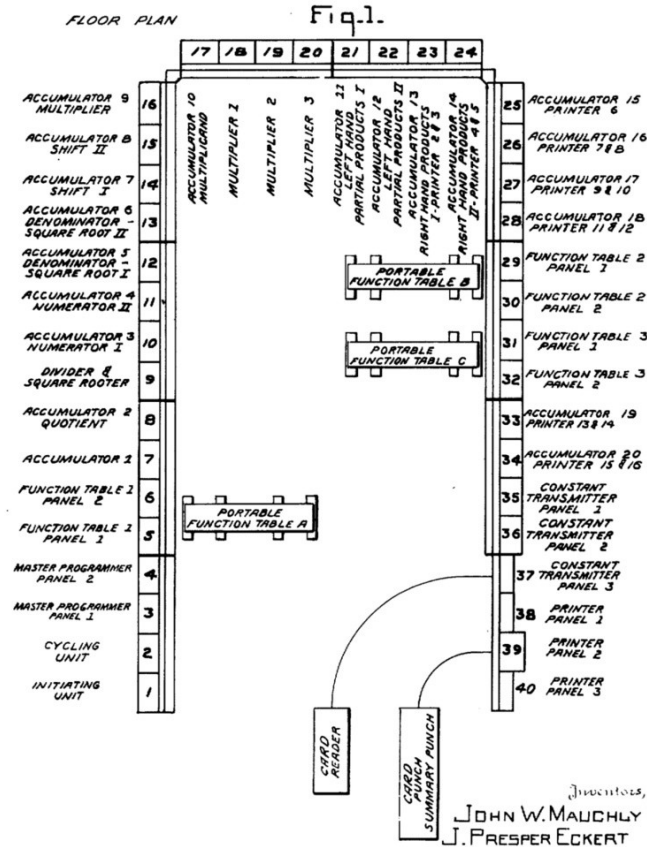

- SSEM
 - Max Newman
 - Tom Kilburn
 - Fred Williams
- Memoria unica
 - Tubi catodici
 - Prototipo
 - Manchester Mk1
 - Ferranti Mk1 e 1*
- Su Nature

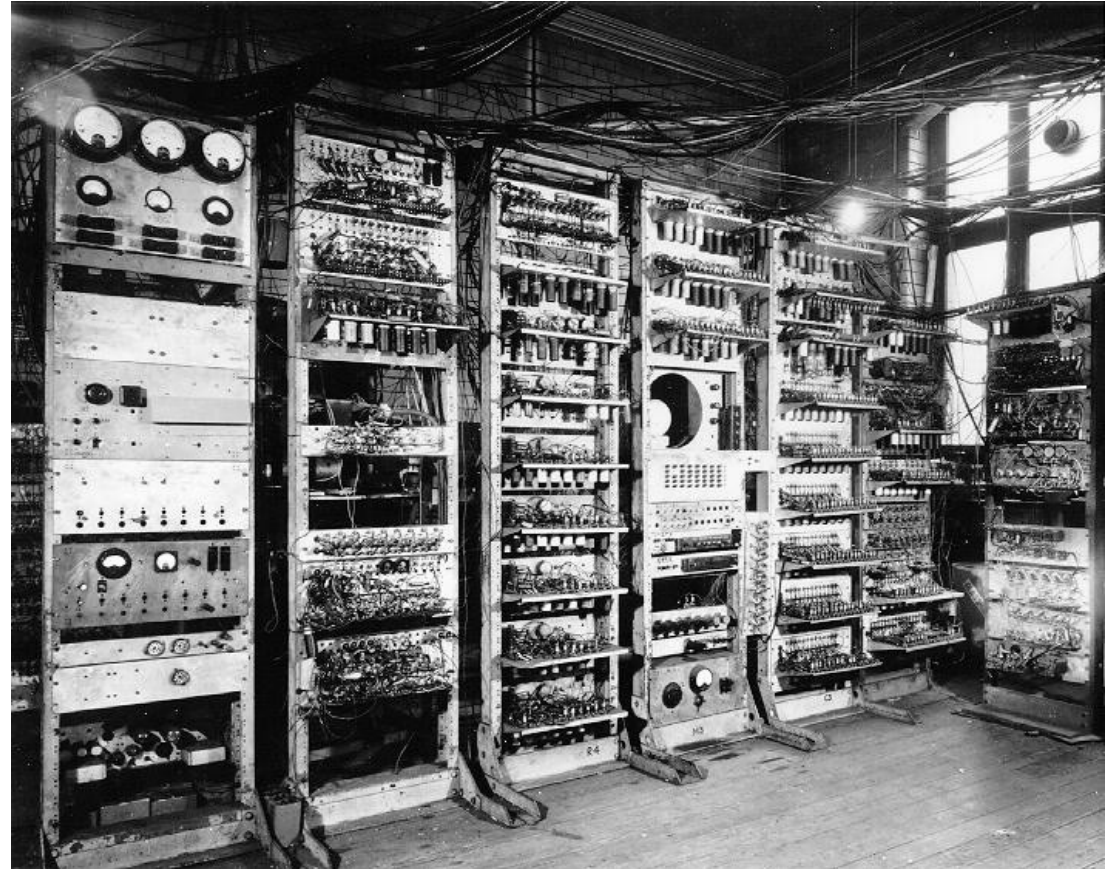

□ Giugno '48

- Il più alto divisore di n
- Tentativi iterativi, sottrazioni e controllo sul resto
- $n = 2^{18}$
3.5M op. in 52'
ca 1100 op/sec

19/7/48 - Kilburn Highest Factor Routine (amended) -

function	C	24	26	27	line	0	1	2	3	4	5	6	7	8	9	10	11	12	13	14	15	16	17	18	19	
-24 C	- b_1	-	-	-	1	0	0	0	1	1	0	1	0	0	0	0	0	0	0	0	0	0	0	0	0	0
-25 C	b_1	-	- b_1	-	2	0	1	0	1	1	1	1	0	0	0	0	0	0	0	0	0	0	0	0	0	0
-26 C	b_1	-	- b_1	b_1	3	0	1	0	1	1	1	1	0	0	0	0	0	0	0	0	0	0	0	0	0	0
-27 C	a	r_{n-1}	- b_1	b_1	4	1	1	0	1	1	1	1	0	0	0	0	0	0	0	0	0	0	0	0	0	0
sub 27	a	r_n	-	-	5	1	1	0	1	1	1	1	0	0	0	0	0	0	0	0	0	0	0	0	0	0
sub 26	r_n	-	-	-	6	1	1	0	1	1	1	1	0	0	0	0	0	0	0	0	0	0	0	0	0	0
-25 C	r_n	r_n	-	-	7	0	1	0	1	1	1	1	0	0	0	0	0	0	0	0	0	0	0	0	0	0
-26 C	r_n	r_n	-	-	8	0	0	1	0	1	1	1	0	0	0	0	0	0	0	0	0	0	0	0	0	0
stop	0	0	- b_1	b_1	9	0	1	0	1	1	1	1	0	0	0	0	0	0	0	0	0	0	0	0	0	0
-26 C	r_n	r_n	- b_1	b_1	10	0	1	0	1	1	1	1	0	0	0	0	0	0	0	0	0	0	0	0	0	0
sub 27	r_n	r_n	-	-	11	1	0	0	1	1	1	1	0	0	0	0	0	0	0	0	0	0	0	0	0	0
-27 C	r_n	r_n	-	-	12	1	0	0	1	1	1	1	0	0	0	0	0	0	0	0	0	0	0	0	0	0
-26 C	r_n	r_n	- b_1	b_1	13	1	0	0	1	1	1	1	0	0	0	0	0	0	0	0	0	0	0	0	0	0
sub 27	r_n	r_n	-	-	14	1	0	0	1	1	1	1	0	0	0	0	0	0	0	0	0	0	0	0	0	0
-27 C	r_n	r_n	- b_1	b_1	15	1	0	0	1	1	1	1	0	0	0	0	0	0	0	0	0	0	0	0	0	0
-26 C	r_n	r_n	- b_1	b_1	16	1	0	0	1	1	1	1	0	0	0	0	0	0	0	0	0	0	0	0	0	0
sub 27	r_n	r_n	-	-	17	1	0	0	1	1	1	1	0	0	0	0	0	0	0	0	0	0	0	0	0	0
-27 C	r_n	r_n	- b_1	b_1	18	1	0	0	1	1	1	1	0	0	0	0	0	0	0	0	0	0	0	0	0	0
sub 26	r_n	r_n	-	-	19	1	0	0	1	1	1	1	0	0	0	0	0	0	0	0	0	0	0	0	0	0
sub 25	r_n	r_n	- b_1	b_1	20	1	0	0	1	1	1	1	0	0	0	0	0	0	0	0	0	0	0	0	0	0

20	-3	10111 etc
21	1	10000
22	4	00100

23	-2	
24	b_1	

25	-	$r_n b_1$
26	-	- b_1
27	-	b_1

or 10100



- Persistenza dei fosfori
 - Scrittura, facile
 - Lettura per tentata scrittura
 - Obbligo di refresh (con lettura)
 - Banchi ispezionabili duplicando il refresh

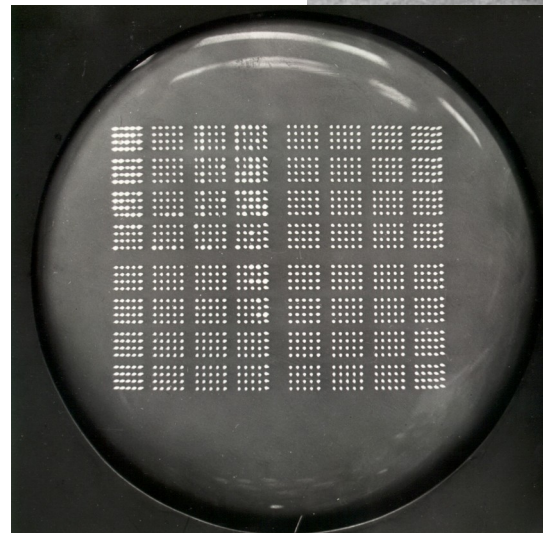
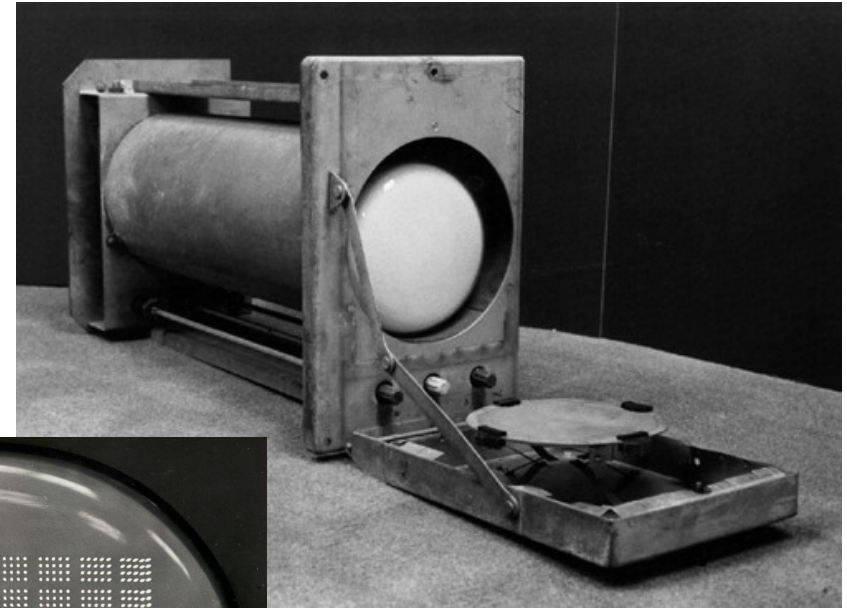

- Progetto
 - Maurice Wilkes
 - David Wheeler
- Caratteristiche
 - Linee di ritardo
 - Initial Orders
 - Wheeler Jump
 - Nastri e telescriventi
 - Citato da Fred Hoyle, in *The Black Cloud*



□ Usato

- Gestione degli utenti
- 87 subroutine nel 1951

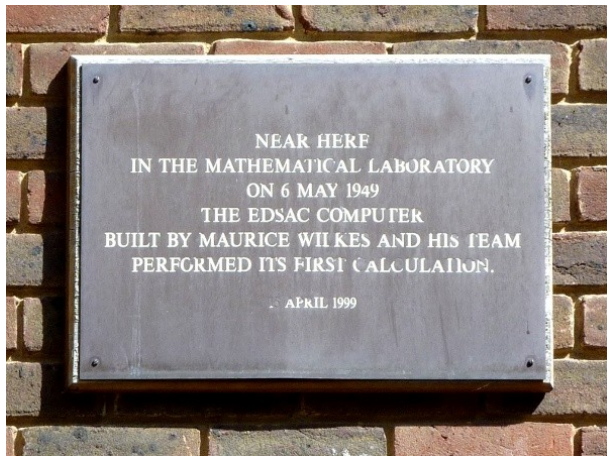

- Diverse velocità di propagazione di un segnale

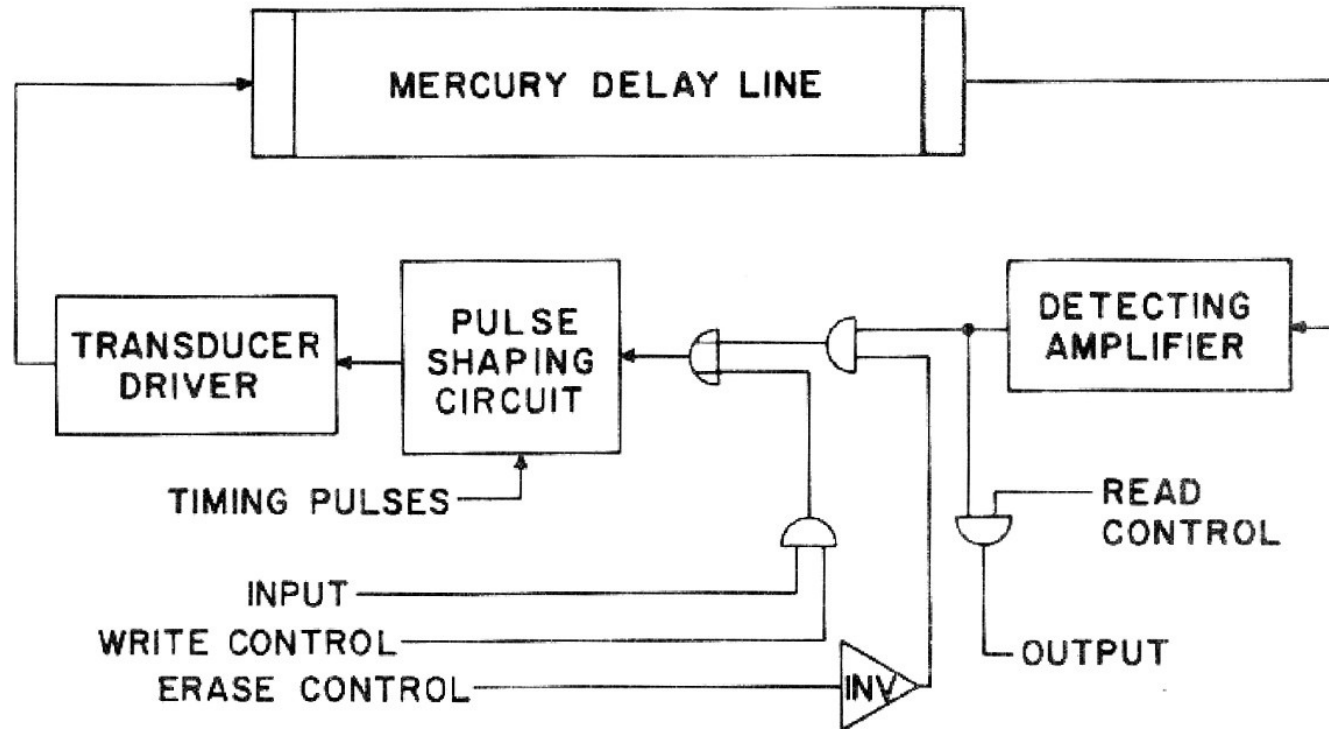

- CSIR Mk1, novembre 1949, Sidney
 - Council of Scientific & Industrial Research
 - Trevor Percey. Suonò, è il più antico conservato
- MЭCM (MESM), 1950, Kiev
 - Small Electronic Calculating Machine,
 - Sergei A. Lebedev
- Pilot ACE, 1950, London
 - Automatic Computer Engine, NPL, Turing
- IAS Machine, 1951, Princeton
 - Institute for Advanced Study, Von Neumann

- Catena
 - Alimentari, tè, biscotti
 - Ristoranti, Corner House
 - Dal 1894

- Organizzata
 - Centro meccanografico
 - Finanziatore di Cambridge

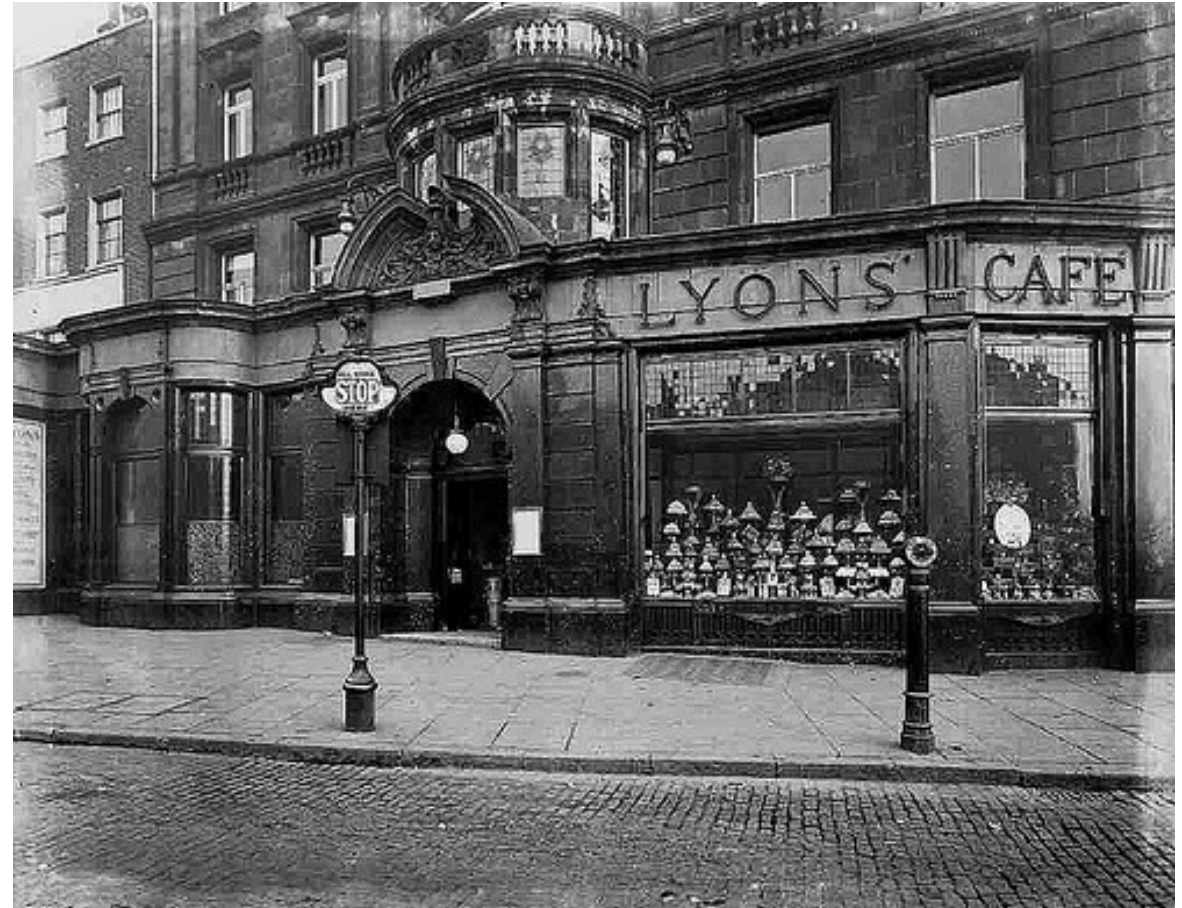

- **Contatti con EDSAC**
 - Via Goldstine
 - Fondi per 3000 £ e un ingegnere

- **Electronic Office**
 - Uso interno, 1951
 - Produzione, 1954
 - 2k parole 35 bit
 - 4 volte l'EDSAC
 - Nastri e telescriventi
 - Schede perforate



- Caratteristiche
 - 20 bit
 - 8 x 64 banchi
 - tamburo magnetico
 - nastri perforati

- 2+7 consegnati
 - Più antica musica registrata
 - Dama, scacchi, testi...



- Universal Automatic Computer
 - Eckert-Mauchly Computer Corporation.
 - 1949, BINAC, alla Northrop
 - 1950, vendita alla Remington Rand
 - 1951, consegnato al Census Office

- Nastri magnetici







- A-0
 - Loader & linker
 - Grace Hopper
- Seguiranno
 - A-3 Arith-matic
 - AT-3 Math-matic
 - B-0 Flow-matic
- 1951-55

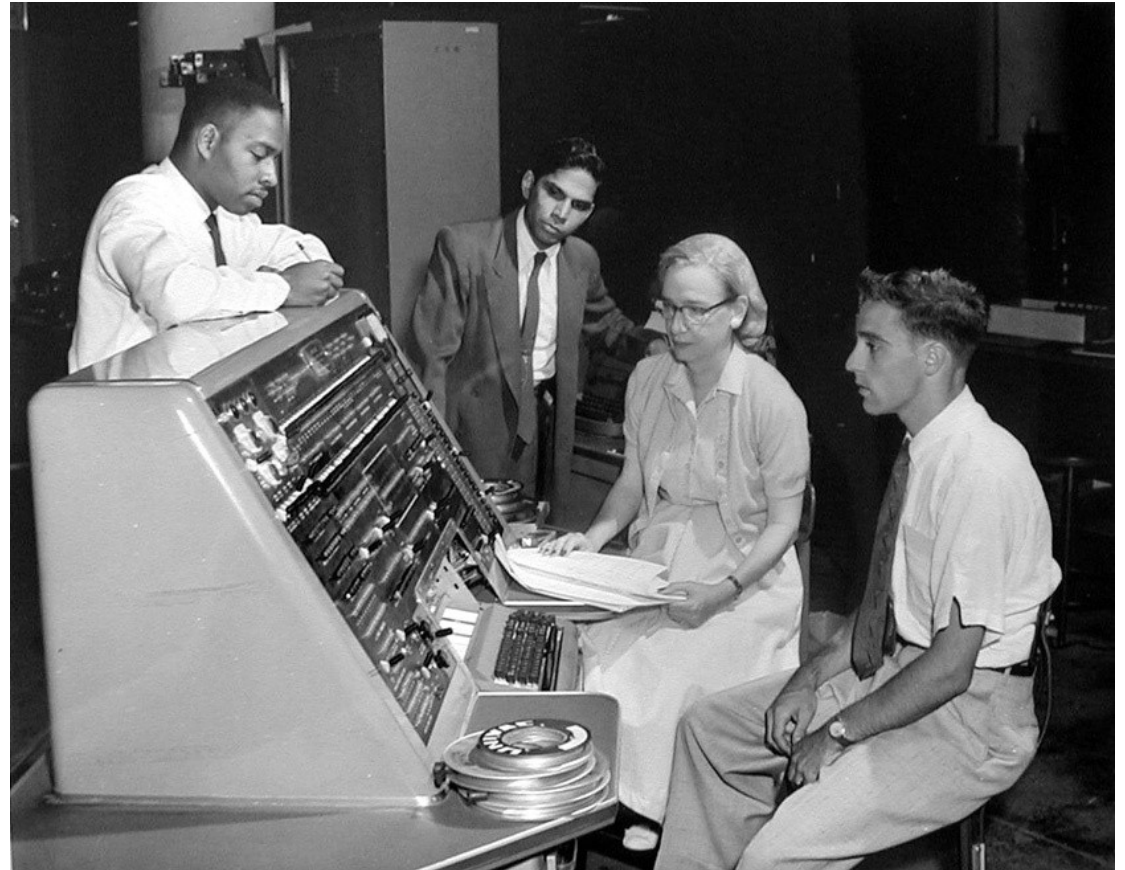

- Selective Sequence Electronic Calculator, 1948
 - Senza Harvard
 - Wallace Eckert
 - Elettronico in parte
 - Curato ed esibito

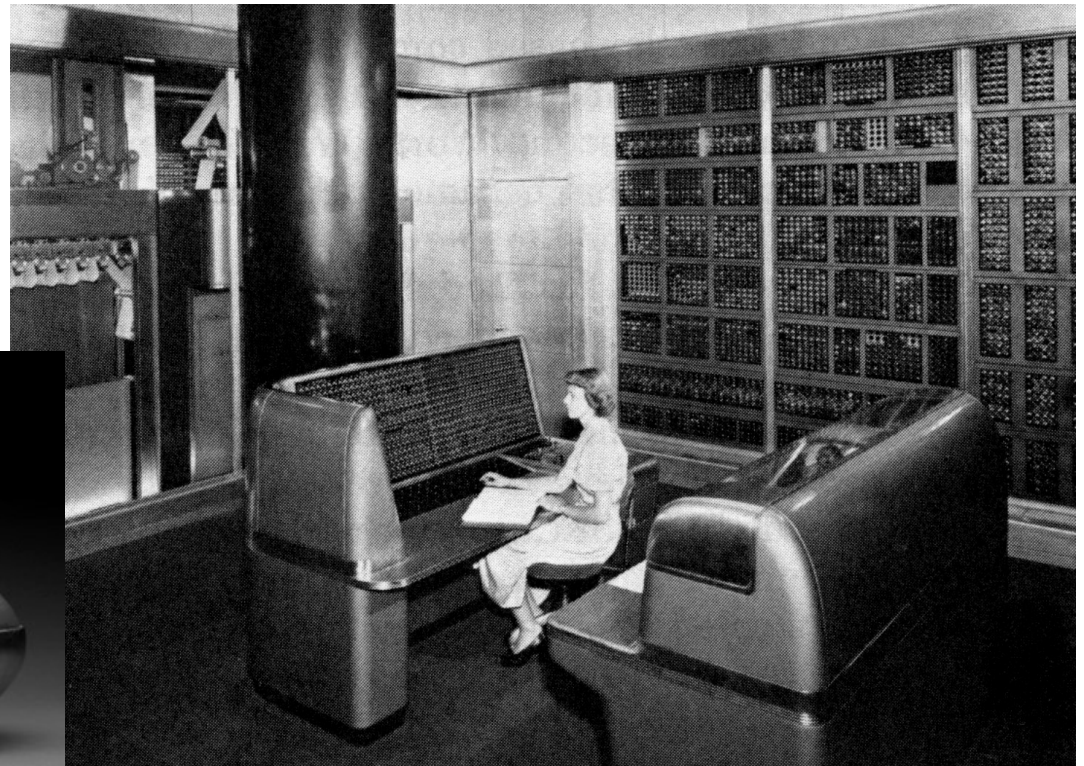
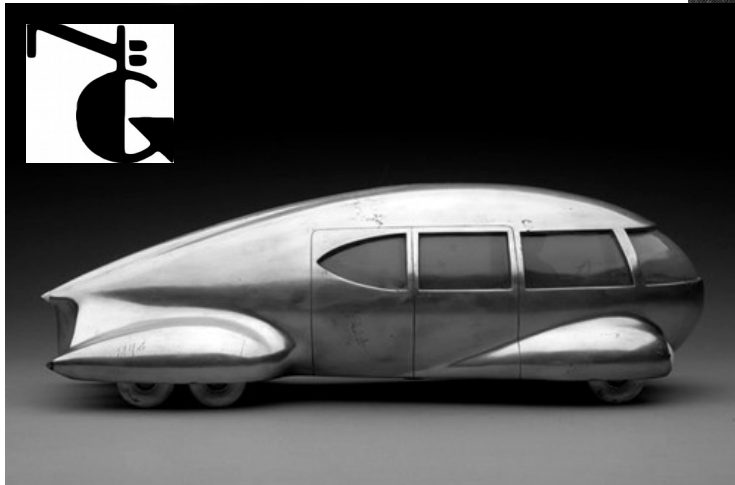

- IBM 701, 1952
 - Calcolatore scientifico commerciale
 - Finanziato dalla difesa
 - Derivato dallo IAS
 - Noleggiato 15-20000\$/mese

- “Al mondo ne bastano 5”
 - Attribuita a T. Watson Sr
 - Affermazione, ben diversa, di T. Watson Jr



- Il timore dei calcolatori
 - Una professione a rischio
 - IBM non li chiama “computer”

- Un mezzo efficace
 - Phoebe & Henry Ephron
 - Walter Lang, regia
 - Electromagnetic Memory and Research Arithmetical Calculator, Emma
 - Ovvio lieto fine



- MIT, per l'US Navy, simulatore di volo
 - Parallelo, 16 bit
 - Tentativo con tubi catodici
 - Memorie a nuclei di ferrite
 - Tempo reale

- Successori
 - TX-0/1, PDP1
 - AN/FSQ-7



- Whirlwind, 1951
 - Jay Forrester
 - Dudley Allen Buck
- Memorie Tormac, 1955
 - Seeburg V200
- An Wang, 1955
 - US Patent 2708722
 - Sottomesso 1949
 - Infine acquistato da IBM



- Il supercalcolatore
 - 4096 x 36 bit
 - 12000 add/sec

- Usato per
 - Fortran
 - John Backus
 - LISP
 - John McCarthy
 - Steve Russel
 - MUSIC
 - Max Matthews

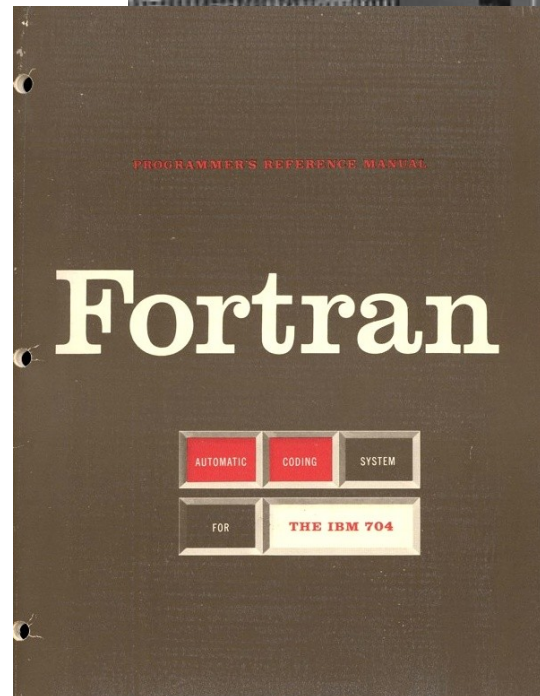
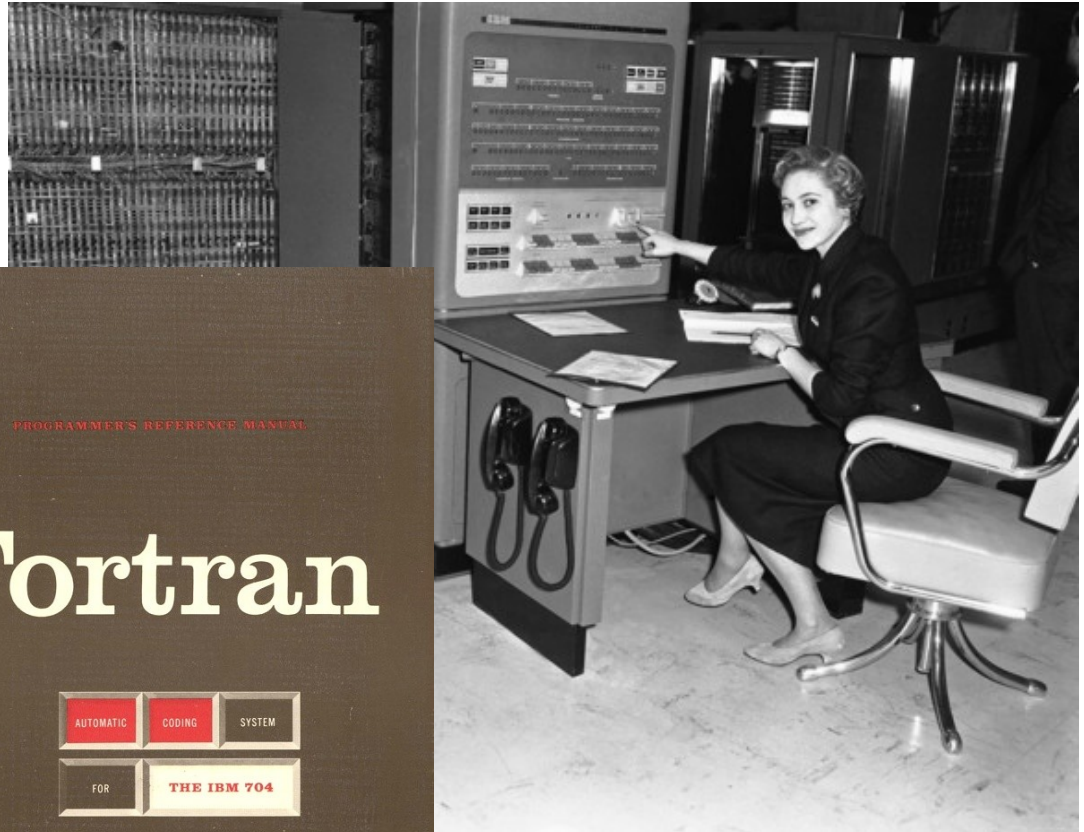

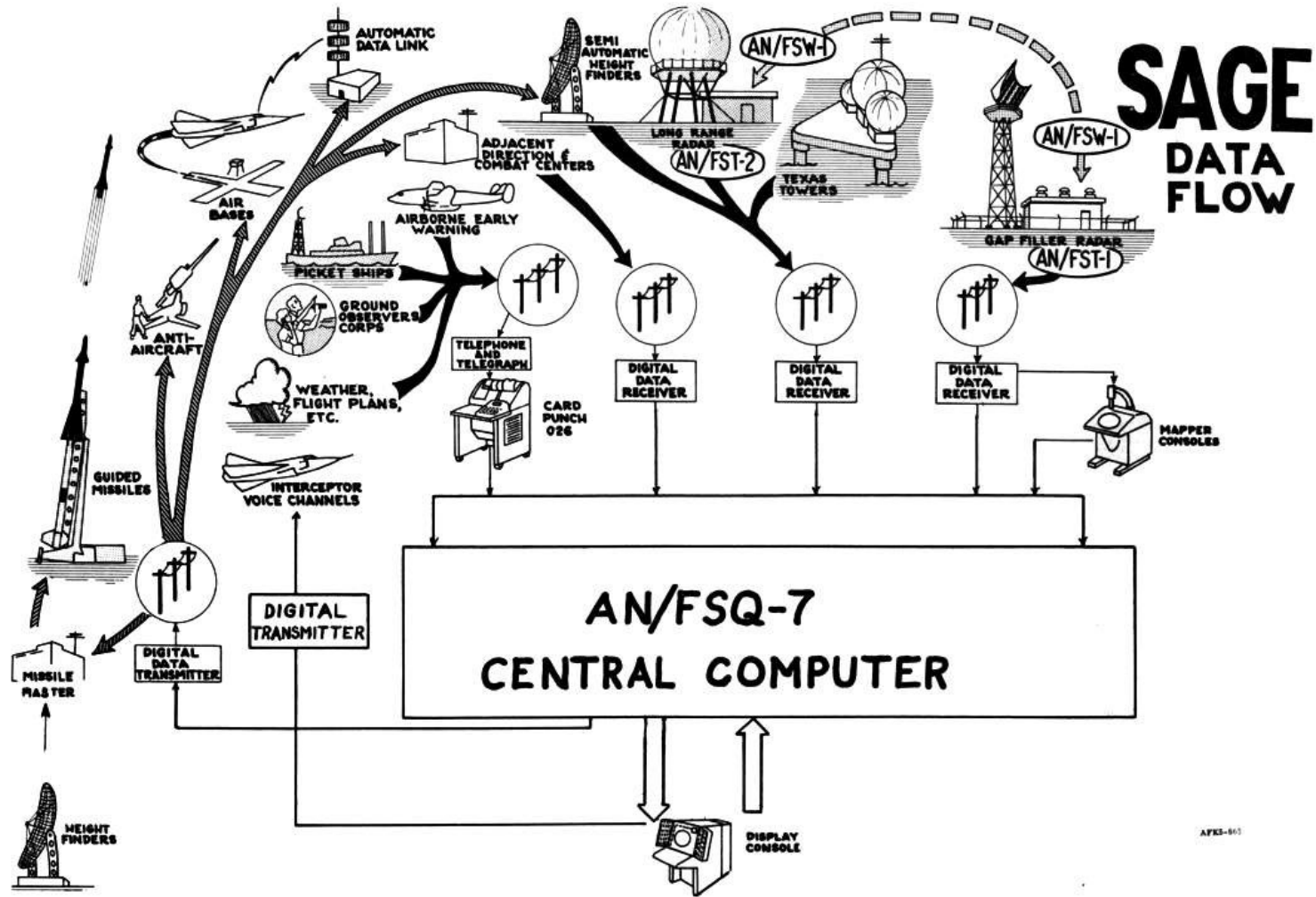

AFKS-643

□ Lungo la Pinetree Line

- Direction Center (32-)
- Control Center (7+2)
- Ogni DC, 2 AN/FSQ7

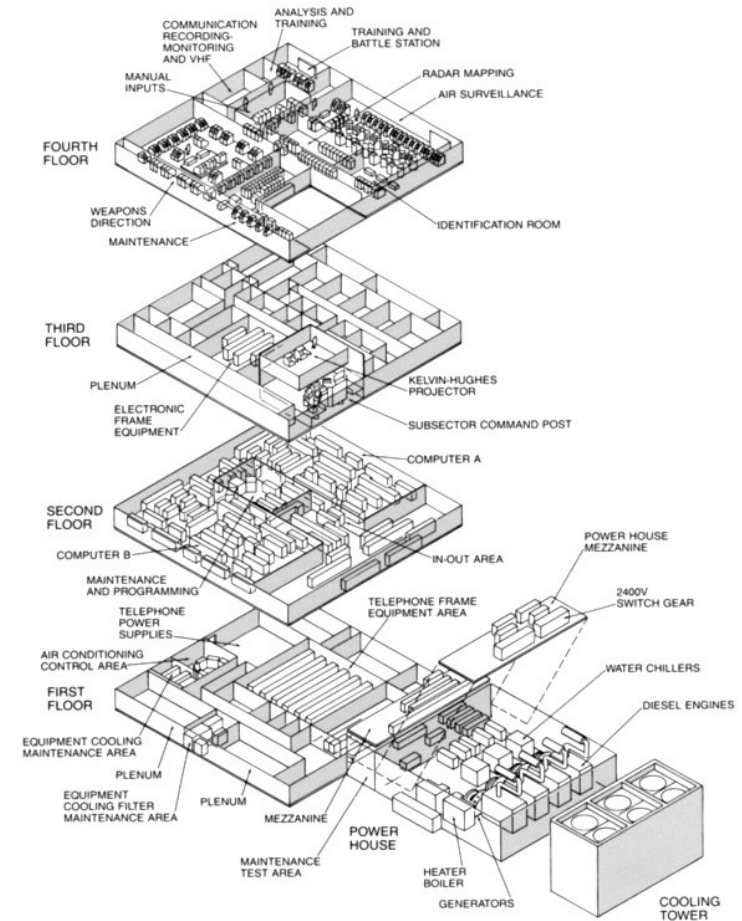

- Il più grande (un primato facile)
 - 250 t (forse 226 Mg)
 - A valvole (60k ca)
 - 3 MegaWatt

- Una star
 - Westworld, 1973
 - Sleeper, 1973
 - Wargames, 1983
 - Independence Day, 1996
 - Lost S2, 2005



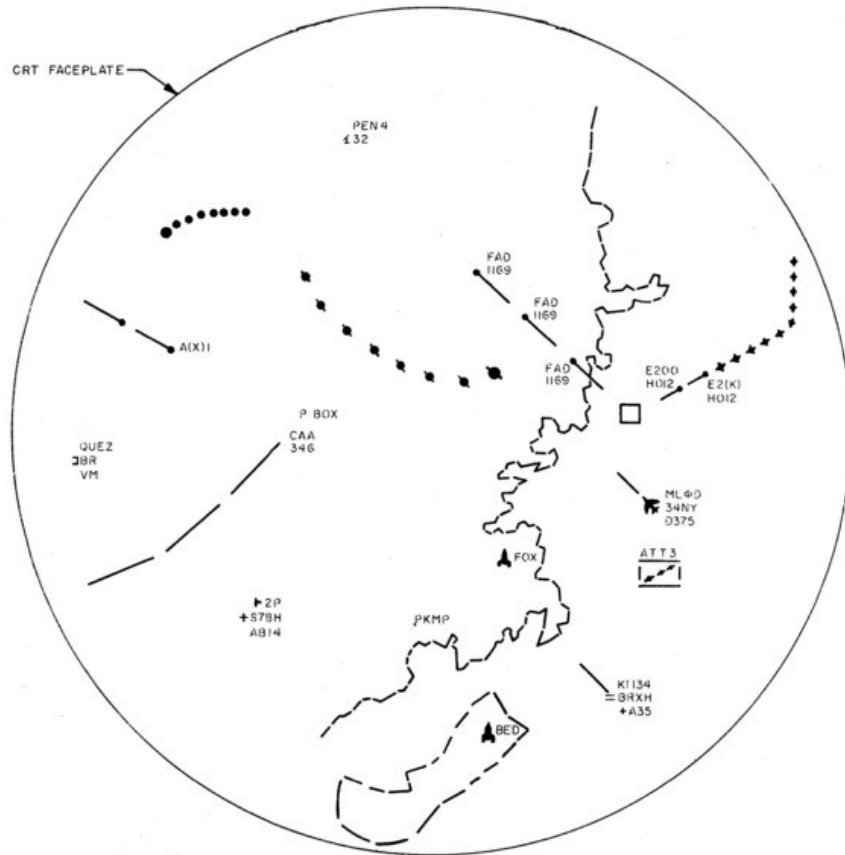

NOTE:
SYMBOLS IN RD MESSAGES WHICH APPEAR LARGER THAN
NORMAL ARE SHOWN IN THIS MANNER TO INDICATE THAT
THEY ARE DISPLAYED BRIGHTLY.

Figure 4-1. Typical Situation Display

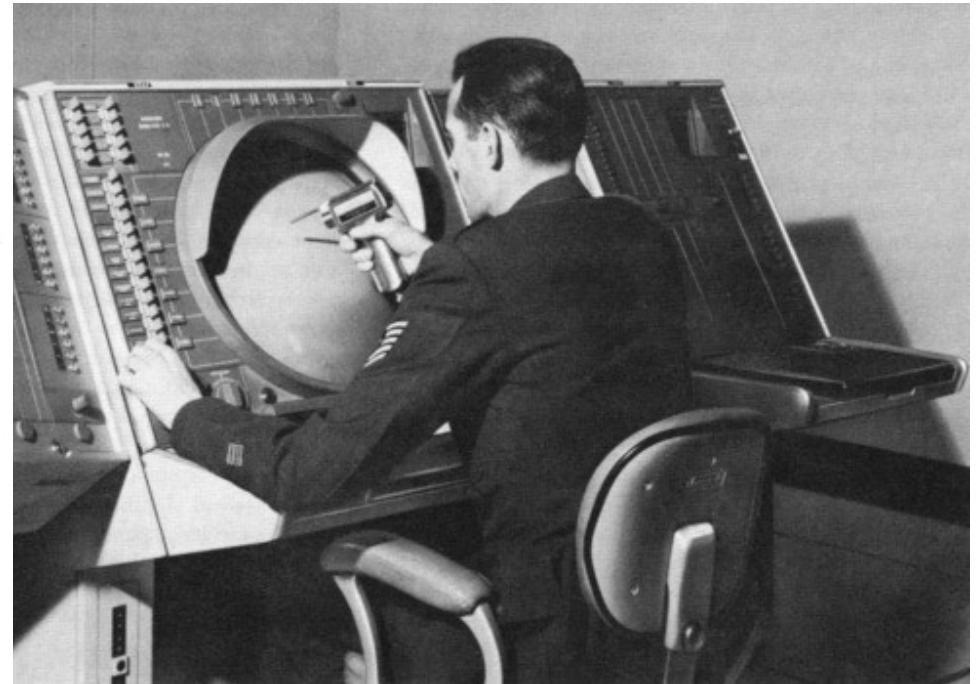

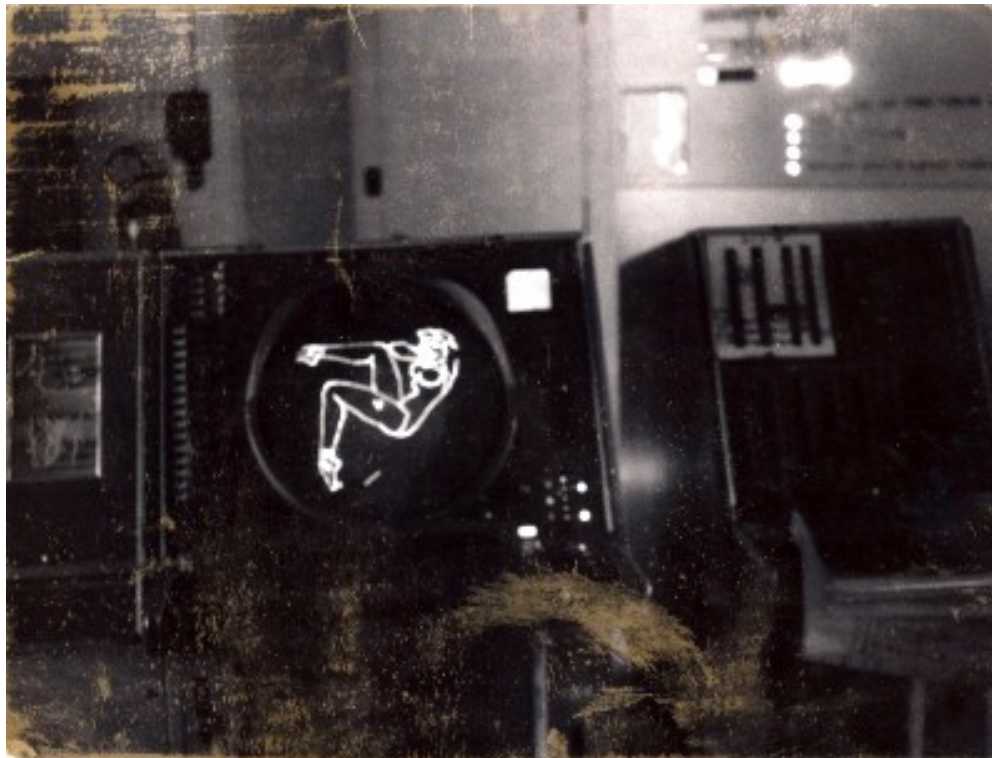

- Bell Labs, 1947
 - J. Bardeen
 - W.B. Shockley
 - W.H. Brattain
 - Nobel nel 1956

- Texas Inst., 1954
 - G.K. Teal
 - Prima germanio
 - Poi silicio



□ Velocemente...

- 1948, il transistor ai Bell Labs
- 1953, Manchester Experimental Transistor Computer
- 1955, Harvell CADET, ancora UK
- 1954, IBM 604, prototipo
- 1956, MIT TX-0
- 1957, IBM 608, commerciale
- 1957, Philco TransAC, commerciale
- 1957, Traitorous Eight & Fairchild Semiconductor
- 1958, Mailüfterl, Vienna
- 1958, Jack Kilby, circuito integrato

□ Ancora più velocemente...

- 1962, Apollo Guidance Computer, MIT & Raytheon
- 1971, TI SN74181, ALU su singolo chip
- 1971, Kenbak-1, CPU su più TTL
- 1971, Intel 4004, Shima (Busicom), Faggin-Hoff-Mazor
- 1974, MITS Altair 8800, su Intel 8080
- 1976, Processor Technology Corp. SOL 20, su 8080
- 1977, PET, Apple II, TRS80 su MOS Technology 6502
- 1980, Commodore VIC-20, sempre su 6502
- 1981, IBM PC, su Intel 8088
- 1984, Macintosh, QL, Amiga su Motorola 68000

- Mini: Digital PDP 8, PDP11
 - 1965-70, 12 → 16 bit
 - PDP 11: oltre 600k venduti
- Mainframe: IBM 360/370...
 - Dal 1964, oggi negli zSystem
 - Come l'*Individual Master File*
- Supercomputer: Cray
 - 1965, CDC 6600, “fast system”
1MFlops, “fastest” fino al '69
 - 1975-82, Cray 1 → X-MP, 80 → 800 MFlops

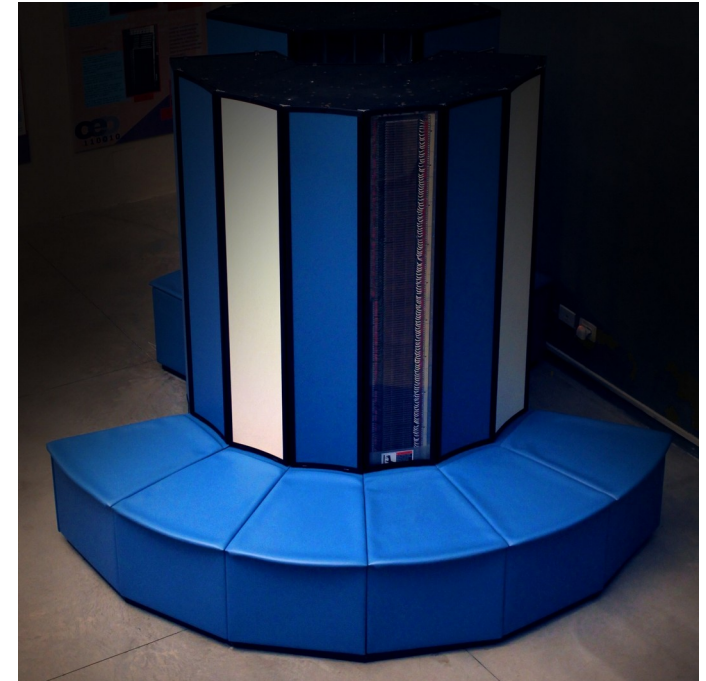

- H.H. Goldstine, “The Computer, from Pascal to Von Neumann”, Princeton Univ. Press, 1972
- Ex www.ibm100.com
- G.A. Cignoni, M. Gazzarri, “Dal taccuino, 3 giugno 1955”, Archivio di Giorgio, 2019.
- G.A. Cignoni, “A volte ritornano”, PaginaQ, 4 marzo, 2014.